



TSL25-280 / TFM25-280

MONTAGEANLEITUNG

Telefon: +49 721 530 772 0

Fax: +49 721 530 772 22

E-Mail: phos@phos.de

PHOS Design GmbH

Wertstraße 12

76189 Karlsruhe

www.phos.de

1 Bohrung

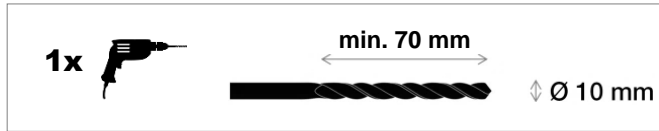
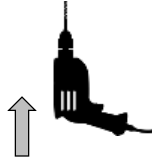
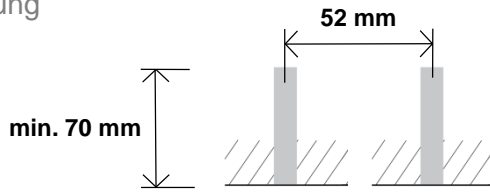

2 Bodenmontage

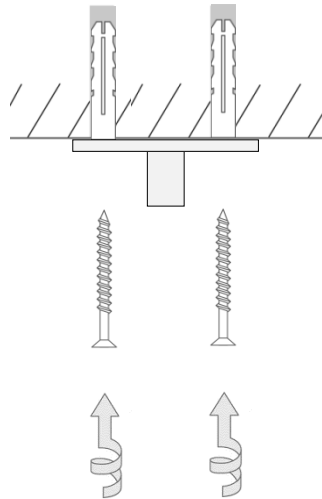
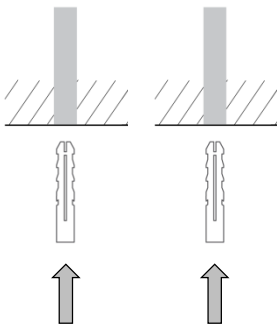

3 Türstoppermontage

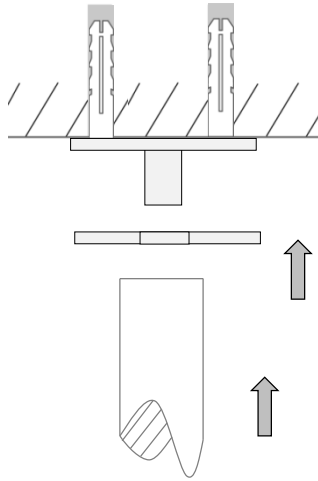

4 Fixierung

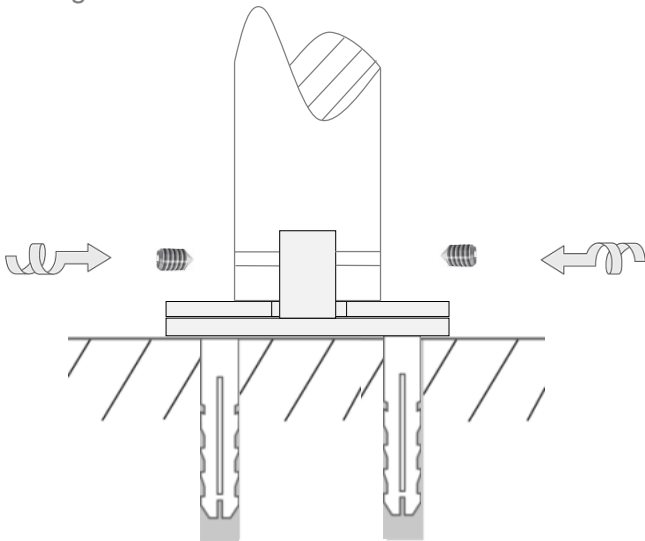

5 Fertigstellung

